	佰善智能科技（湖北）有限公司 Baishan Intelligent technology (Hubei) Co., Ltd. 深圳市科宇电源科技有限公司 Shenzhen Keyu Power Supply Technology Co., Ltd.		REVISION (版本)	A/0
			DATE (日期)	2026-02-06
PART NUMBER (样单编号)	KA1947009	CUSTOMER MODEL (客户型号)		

APPROVAL SHEET

(承认书)

FOR

AC/DC ADAPTER

(适配器)

MODEL NO.

(型号)

KA1801A-0503000EU

Color 颜色: (Black 黑色) (White 白色)

MANUFACTURER (制造商)				
EDIT (制订)	CONFIRM (品质部确认)	CONFIRM (研发部确认)	CHECK (审核)	APPROVAL (批准)
孙冰冰				

说明: 实际生产中如有使用替代物料均在承认书中所列物料清单之中, 我司不再另做报备通知, (替代料均测试合格, 满足功能和安规) 请知悉:

CUSTOMER APPROVAL



(客户承认)

签收:

印章:

日期:



- ◆ **Address:** Bldg. 2-1 & 2-2, Photoelectric Industrial Park, Jianli Economic Development Area, Jianli County, Jingzhou City, Hubei, China (湖北)
- ◆ **Address:** 1-8F, No.13, Lane 3, Yuquan East Road, the 2nd Industrial park, Yulu, Guangming District, Shenzhen, Guangdong, China (深圳)
- ◆ **Tel:** 07163666919 (湖北) (86-755) 27826629 (深圳)
- ◆ **Fax:** (86-755) 27827839
- ◆ **Website:** www.kysdy.com

 	佰善智能科技（湖北）有限公司 Baishan Intelligent technology (Hubei) Co., Ltd. 深圳市科宇电源科技有限公司 Shenzhen Keyu Power Supply Technology Co., Ltd.		REVISION (版本)	A/0
			DATE (日期)	2026-02-06
PART NUMBER (样单编号)	KA1947009	CUSTOMER MODEL (客户型号)		

CONTENTS

目 录

1. General Description(概述)	4
2. Environment Protection Laws（环保法规）	4
3. According with Safety and EMC Criterion（符合的安全及电磁兼容标准）	4
4. Safety and EMC Approval（已认可的安全 及电磁兼容标准）	4
5. Test Circuit (测试电路)	4
6. Input Characteristics（输入特性）	5
7. Output Characteristics（输出特性）	5
8. Reliability Items (可靠性项目)	7
9. Mechanical Requirement（机械要求）	8
10. Environmental Performances(环境性能)	8
11. Product Outline Drawing（制品结构尺寸图）	9
12. DC Output Cable and Plug Drawing（输出线材图）	10
13. Rating Label Drawing（标贴纸图）	11
14. Packaging vector diagram（包装矢量图）	12
15. List of key materials（关键材料清单）	13

 	佰善智能科技（湖北）有限公司 Baishan Intelligent technology (Hubei) Co., Ltd. 深圳市科宇电源科技有限公司 Shenzhen Keyu Power Supply Technology Co., Ltd.		REVISION (版本)	A/0
			DATE (日期)	2026-02-06
PART NUMBER (样单编号)	KA1947009	CUSTOMER MODEL (客户型号)		

1. General Description(概述)

This specification defines the input, output, performance characteristics, and environment, noise and safety requirements for **15Watts** adaptor. (The environment temperature is 25°C or aging test after 15 minutes) , this product is for indoor use only.

(本规格详细说明了 **15W** 的适配器输入、输出特性、环境、噪音和安全要求。(环境温度为 25 度或老化 15 分钟后进行测试)，本产品只限室内使用。

2. Environment Protection Laws (环保法规)

ROHS
 REACH
 CPSIA
 EN71
 PHTHALATE
 HALOGEN

3. According with Safety and EMC Criterion (符合的安全及电磁兼容标准)

EN62368
 EN61558-1
 EN60065-1
 EN55032
 UL60950-1
 UL1310
 UL60065-1
 EN55035
 GB4943.1
 GB9254
 GB17625.1
 FCC Part15
 J60065
 J55013

4. Safety and EMC Approval (已认可的安全 及电磁兼容标准)



CB
 TUV/GS
 CE
 PSE
 UL
 FCC
 SAA
 C-tick
 KC
 CCC
 J TLC
 E-mark

5. Test Circuit (测试电路)

If the test is to be made on a specified circuit, be sure to use the following circuit.

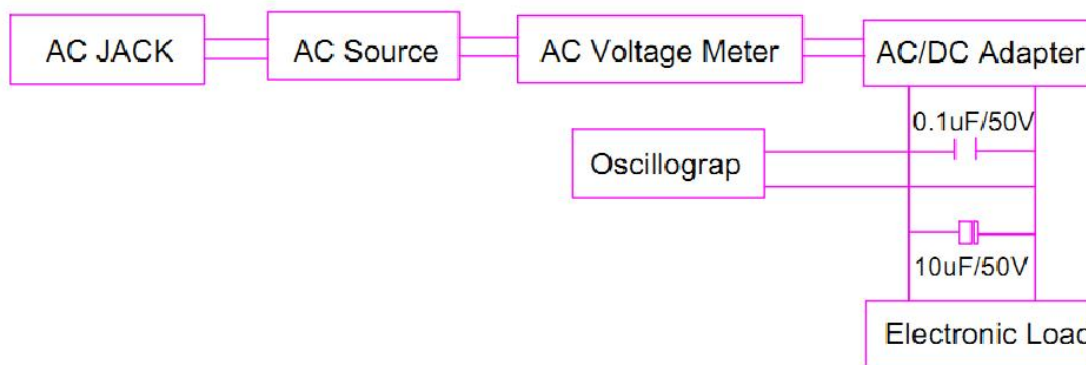
(无特殊规定的情况下依照下面的电路进行测试.)



 	佰善智能科技（湖北）有限公司 Baishan Intelligent technology (Hubei) Co., Ltd. 深圳市科宇电源科技有限公司 Shenzhen Keyu Power Supply Technology Co., Ltd.		REVISION (版本)	A/0
			DATE (日期)	2026-02-06
PART NUMBER (样单编号)	KA1947009	CUSTOMER MODEL (客户型号)		

6. Input Characteristics (输入特性)

6.1 Input Voltage and Frequency (输入电压及频率)

6.1.1 Rated Input voltage 额定输入电压: **100~240V**

6.1.2 Reliable Input voltage 输入电压范围: **90~264V**

6.1.3 Rated Input Frequency 额定输入频率: **50~60Hz**

6.1.4 Reliable Input Frequency 输入频率范围: **47~63Hz**

6.2 Steady AC Current (AC 输入电流)

The maximum input current shall be less than **0.55A** at 100~240Vac input

(在额定输入电压 100V~240V 时输入电流小于 **0.55A**)

6.3 Inrush Current (峰值输入电流)

With cold starting, input AC 240V the inrush current should **60A** Max

(电源启动时最大峰值输入电流小于 **60A**)

6.4 Standby (待机功耗)

The input power shall be less than **0.1W** at 115 or 230Vac input

(在输入电压 115V 或 230V 时待机功耗小于 **0.1W**)

6.5 Full load Efficiency (满载效率)

Measured at 115Vac or 230Vac input voltage, 100% load ,The efficiency is **78%** Min

(在输入电压 115Vac 或 230Vac, 输出带满载效率不低于 **78%**)

6.6 Average Efficiency (平均效率)

Measured at 115Vac or 230Vac input voltage, Average efficiency can reach energy star VI

(**81.39%**) standard

(在输入电压 115Vac 或 230Vac, 平均效率可达到能效六级 **81.39%**标准)

7. Output Characteristics (输出特性)

7.1 Rated Output Voltage&Current (额定输出电压和电流)

No load voltage (空载输出电压范围): **4.7V ~ 5.3V**



Full load voltage (满载输出电压范围): **4.7V ~ 5.3V** (内正外负 inside:+; outside:-)

Rated Output Current(额定输出电流): **3A**

7.2 Hold-up Time (关机维持时间)

The maximum turn-off hold-up time shall be least **10mS** at input 230Vac and the rated load condition.

(在输入 230Vac 及额定负载情况下,关机输出维持时间不低于 **10mS**)

 	佰善智能科技（湖北）有限公司 Baishan Intelligent technology (Hubei) Co., Ltd. 深圳市科宇电源科技有限公司 Shenzhen Keyu Power Supply Technology Co., Ltd.		REVISION (版本)	A/0
			DATE (日期)	2026-02-06
PART NUMBER (样单编号)	KA1947009	CUSTOMER MODEL (客户型号)		

7.3 Output Rise Time (输出上升时间)

Input 110Vac/230Vac and rated load, The rise time shall not exceed **50mS** that the output voltage rise from 10% to 90% rated voltage.

(在输入 110Vac/230Vac,输出额定负载条件下,输出电压由 10%额定电压上升至 90%额定电压的上升时间不会超过 **50mS**)

7.4 Output Fall Time (输出下降时间)

Input 110Vac/230Vac and rated load,**20mS** max

(输入 110Vac/230Vac & 输出额定负载, 最大 **20mS**)

7.5 Turn - on Delay Time(开机延迟时间)

3S max. @ 100Vac to 240Vac input & Full load

(100-240Vac 输出满载开机延迟时间最大 **3** 秒)

7.6 Rated Power (额定功率)

This adaptor is capable to support **15Watts** continuously at all specified conditions.

(此产品额定功率为 **15W**)

7.7 Ripple and Noise (纹波和噪音) (AC100V-240V 测试)

Ripple voltage is **150mV** p-p (Full load **3A**) measured methods: Performed by 20MHz bandwidth in oscilloscope Applied 0.1uF ceramic capacitor and 10uF electrolytic capacitor across output connector terminals Measured at the end of DC cable. The environment temperature is 25°C or aging test after 15 minutes.

(输出端并 0.1uF 与 10uF 电容, 限制示波器带宽 20MHz 时, 测得纹波小于 **150mV** p-p,输出负载 **3A**, 环境温度为 25 度或老化 15 分钟后进行测试)

7.8 Protection (保护)

7.8.1 Over Current Protection (过流保护)



OCP Point Limited: **110%~200%** of Max. Load. The output shall hiccup when the over current applied to the output, and shall be self-recovery when the fault condition is removed

(过电流点为最大负载的 **1.1~2.0** 倍, 输出将进入打嗝模式, 当过电流情况解除后, 产品将会自动恢复正常)

7.8.2 Short Circuit Protection (短路保护)

The input power shall decrease when the output short, the power supply shall no damage, and shall be self-recovery when the fault condition is removed.

(当输出短路时,产品输入功率降低且不会损伤,当短路情况解除后,产品将会自动恢复正常)

 	佰善智能科技（湖北）有限公司 Baishan Intelligent technology (Hubei) Co., Ltd. 深圳市科宇电源科技有限公司 Shenzhen Keyu Power Supply Technology Co., Ltd.		REVISION (版本)	A/0
			DATE (日期)	2026-02-06
PART NUMBER (样单编号)	KA1947009	CUSTOMER MODEL (客户型号)		

8. Reliability Items (可靠性项目)

8.1 Electrostatic discharge (静电)

At 150pF: 330Ω, for each point, 10 shots of direct discharge or air discharge (1 MΩ/ SHOT), have no malfunction. Direct discharge: **±4kV**, Air discharge: **±8kV**

(在接触放电**±4kV**和空气中放电**±8kV**模式下,各处分别放电 10 次无误动作)

8.2 Hi-Pot Test (高压测试)

Primary to Secondary: **3000Vac / 10mA Max / 60S** (when safety testing)

初级对次级: **3000Vac / 10mA Max / 60 秒** (安规试验)

Primary to Secondary: **3300Vac / 5mA Max / 3S** (when production)

初级对次级: **3300Vac / 5mA Max / 3S**(生产作业)

8.3 Insulation Resistance (绝缘电阻)

100MΩ Min. between primary to secondary add **500Vdc** test voltage.

在初级与次级间加 **500Vdc** 进行测试, 最小 **100MΩ**。

8.4 Leakage Current (泄漏电流)

0.25mA maximum, at nominal AC input voltage and frequency

(输入时泄漏电流不得 **0.25mA Max**)

8.5 Burn-In Test (老化测试)

2 hours at **40°C** maximum, Normal input voltage, rated load.

(在高温 **40°C** 工作 **二小时** 情况下, 额定输入电压和负载条件下)

8.6 Lightning surge (雷击浪涌)

EMS Standards/EMS 标准

SURGE LEVEL: **±1KV**(DM), **±2KV**(CM) Standards IEC61000-4-5

雷击 等级: **±1KV**(差模), **±2KV**(共模) 标准 IEC61000-4-5

Note: Power supply is not damaged, allowing restart



备注: 电源不损坏, 允许重启

8.7 MTBF (平均无故障时间)

When the power supply is operating within the limits of this specification the MTBF

shall be at least **50000** hours at **25°C** (MIL-HDBK-217F).

(当电源在本规范运行时, 平均无故障时间在 **25°C** 至少为 **50000** 小时 MIL-HDBK-217F)

 	佰善智能科技（湖北）有限公司 Baishan Intelligent technology (Hubei) Co., Ltd. 深圳市科宇电源科技有限公司 Shenzhen Keyu Power Supply Technology Co., Ltd.		REVISION (版本)	A/0
			DATE (日期)	2026-02-06
PART NUMBER (样单编号)	KA1947009	CUSTOMER MODEL (客户型号)		

9. Mechanical Requirement (机械要求)

9.1 Weight (重量)

113g±10g

9.2 Input plug type (输入插头类型)

Wall-mounted type. EU-pin. 2 Conductors, < Live. Neutral > (欧规 AC 输入 2PIN 插头)

9.3 Drop Test (跌落试验)

1M for wall mount type and 0.76M for desktop as above described. Test times for each 1 times, a total of 6 times

插墙式跌落高度为 1 米、桌面式跌落高度为 0.76 米；试验次数为每面 1 次，共 6 次。

The horizontal surface consists of hardwood at least 13mm thick, the plug can be bend, and scratch, but the structure should not be damaged, and can work normally

测试台面是厚 13mm 的夹木板,测试后插脚可以弯曲, 外壳可以有伤但外观不能有结构性损毁, 能正常工作。

9.4 Vibration (振动)

10 to 300Hz sweep at a constant acceleration of 1.0G(Breadth: 3.5mm) for 1Hour for each of the perpendicular axes X, Y, Z

(扫描频率: 10 to 300Hz, 加速度: 1.0G(位移: 3.5mm), X, Y, Z 三垂直坐标轴向各振动 1 小时)

10. Environmental Performances(环境性能)

10.1 Operating Temperature and Relative Humidity(工作温度和湿度要求)

0°C to +40°C

10%RH to 90%RH

10.2 Storage Temperature and Relative Humidity(储存温度和湿度要求)

-25°C to +70°C

5%RH to 95%RH non-condensing

10.3 Noise(噪声)



A weighted sound pressure levels should be consistently under 30 dB at 30cm from PSU.

(在静音环境距产品 30 厘米处测试, 产品噪声小于 30dB)

	佰善智能科技（湖北）有限公司 Baishan Intelligent technology (Hubei) Co., Ltd. 深圳市科宇电源科技有限公司 Shenzhen Keyu Power Supply Technology Co., Ltd.		REVISION (版本)	A/0
			DATE (日期)	2026-02-06
PART NUMBER (样单编号)	KA1947009	CUSTOMER MODEL (客户型号)		

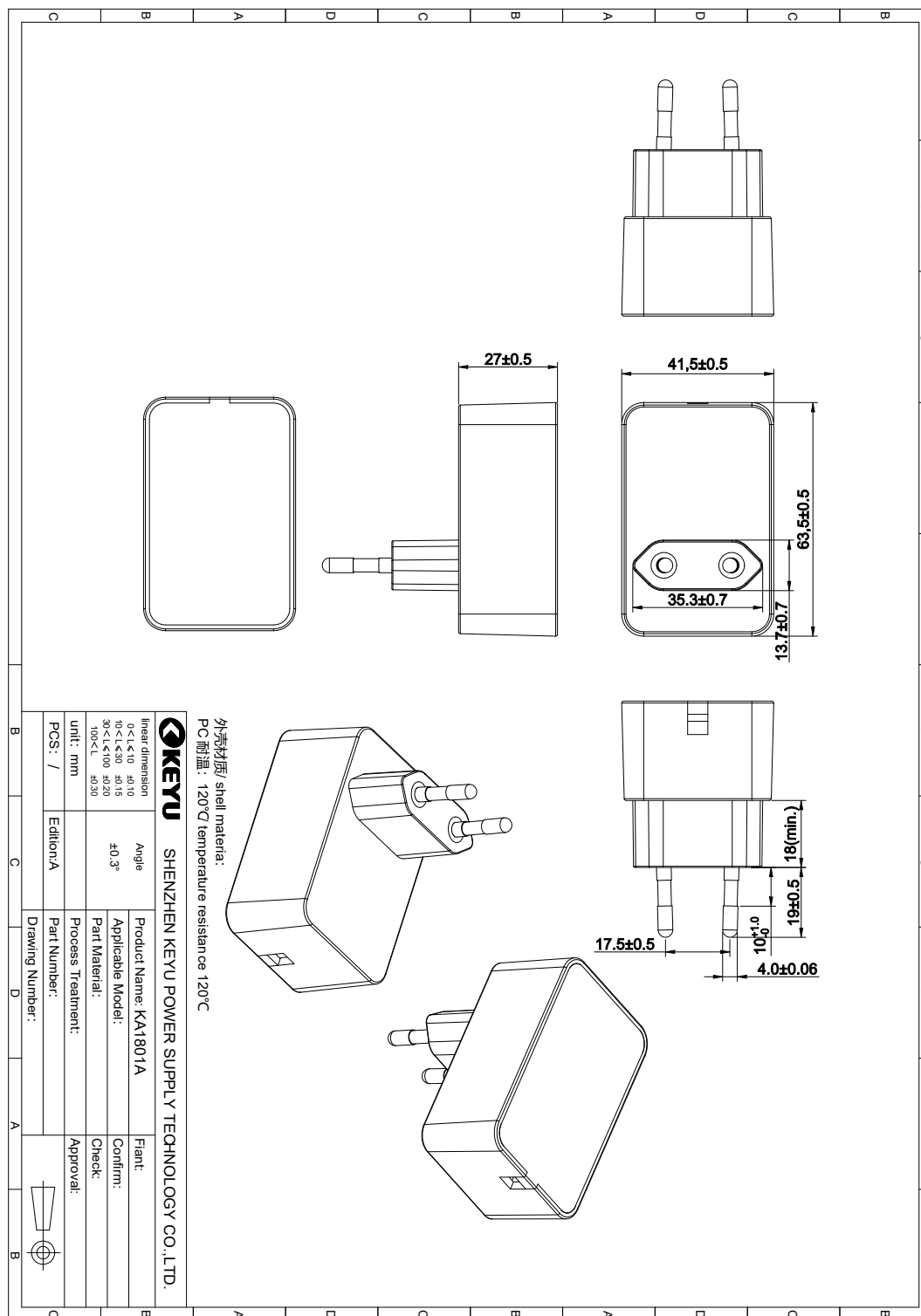
11. Product Outline Drawing (制品结构尺寸图)



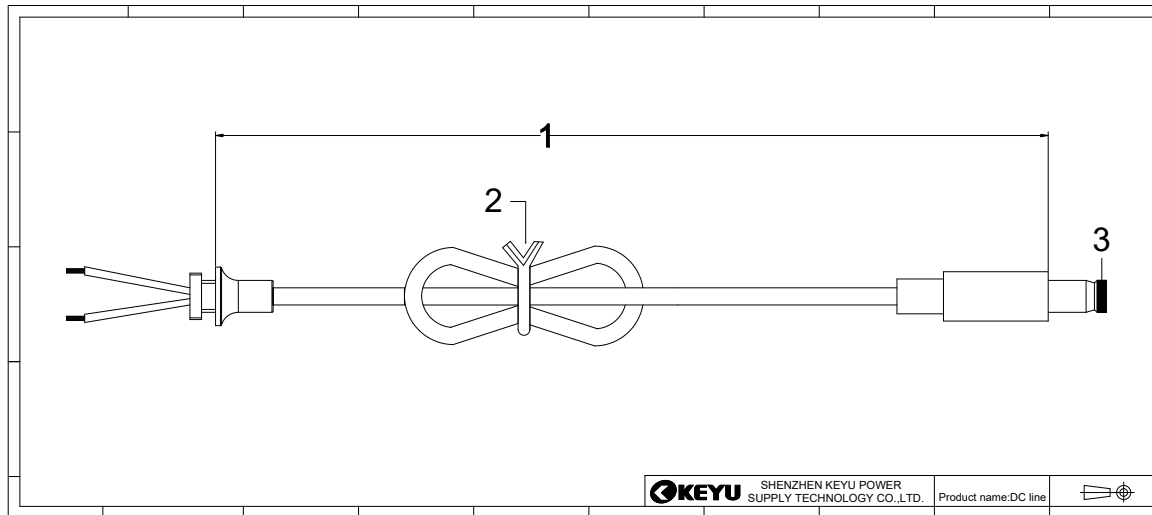

 	佰善智能科技（湖北）有限公司 Baishan Intelligent technology (Hubei) Co., Ltd. 深圳市科宇电源科技有限公司 Shenzhen Keyu Power Supply Technology Co., Ltd.		REVISION (版本)	A/0
			DATE (日期)	2026-02-06
PART NUMBER (样单编号)	KA1947009	CUSTOMER MODEL (客户型号)		

12. DC Output Cable and Plug Drawing (输出线材图)



Note/备注:

1. Cable/线材: **UL2464 20AWG** Cable length/线材长度: **1000±30mm** 80°C 300V VW-1, black color/黑色
2. 扎线后/ After binding length: **80±20mm**
3. DC Plug /DC 插头: **5.5*2.1*10±0.3mm**, inside "+", outside "-" /内正外负
4. Appearance details are subject to the actual samples/外观详情参考实物为准
5. Cord cycling bending test requirements: Heavy: **200g**, 120 degrees, Frequency: 45 / minute, more than **2,000** times/摇摆测试要求: 吊重: **200g**, 120 度, 频率: 45 次/分, **2000** 次以上;
6. Label UL number on the cable: **E531821 BAISHAN/E315696(XIE JIN), E479504(DIAN ZHI ZHOU)**
/线身丝印 UL 号: **E531821 BAISHAN/E315696(XIE JIN), E479504(DIAN ZHI ZHOU)**

 	佰善智能科技（湖北）有限公司 Baishan Intelligent technology (Hubei) Co., Ltd. 深圳市科宇电源科技有限公司 Shenzhen Keyu Power Supply Technology Co., Ltd.		REVISION (版本)	A/0
			DATE (日期)	2026-02-06
PART NUMBER (样单编号)	KA1947009	CUSTOMER MODEL (客户型号)		

13. Rating Label Drawing (标贴纸图)

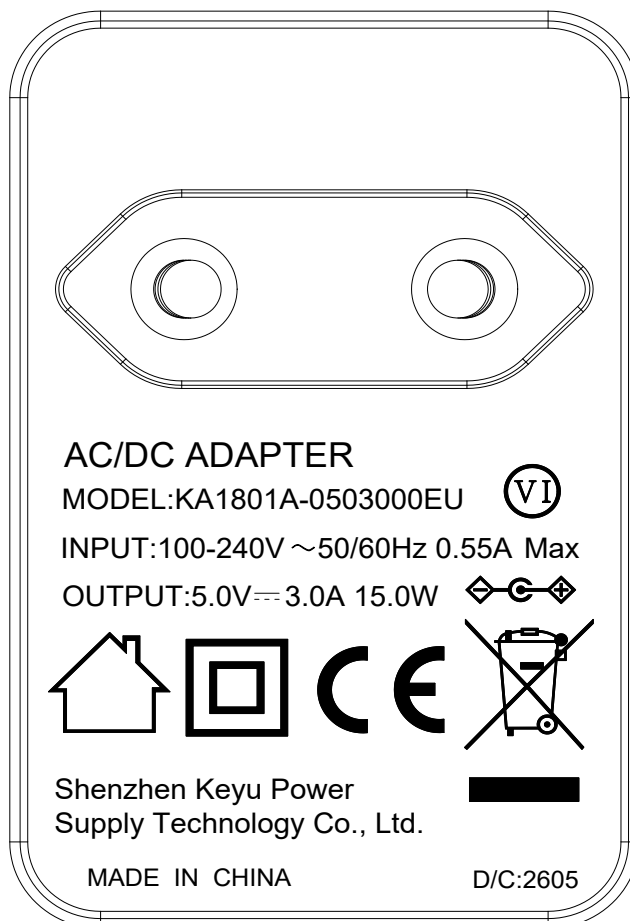

Note: "D/C:2605": 26 for the year of production, 05 for the production cycle, D/C will be updated with the production cycle

标贴：镭射 (laser)

	佰善智能科技（湖北）有限公司 Baishan Intelligent technology (Hubei) Co., Ltd. 深圳市科宇电源科技有限公司 Shenzhen Keyu Power Supply Technology Co., Ltd.		REVISION (版本)	A/0
			DATE (日期)	2026-02-06
PART NUMBER (样单编号)	KA1947009	CUSTOMER MODEL (客户型号)		

14. Packaging vector diagram (包装矢量图)

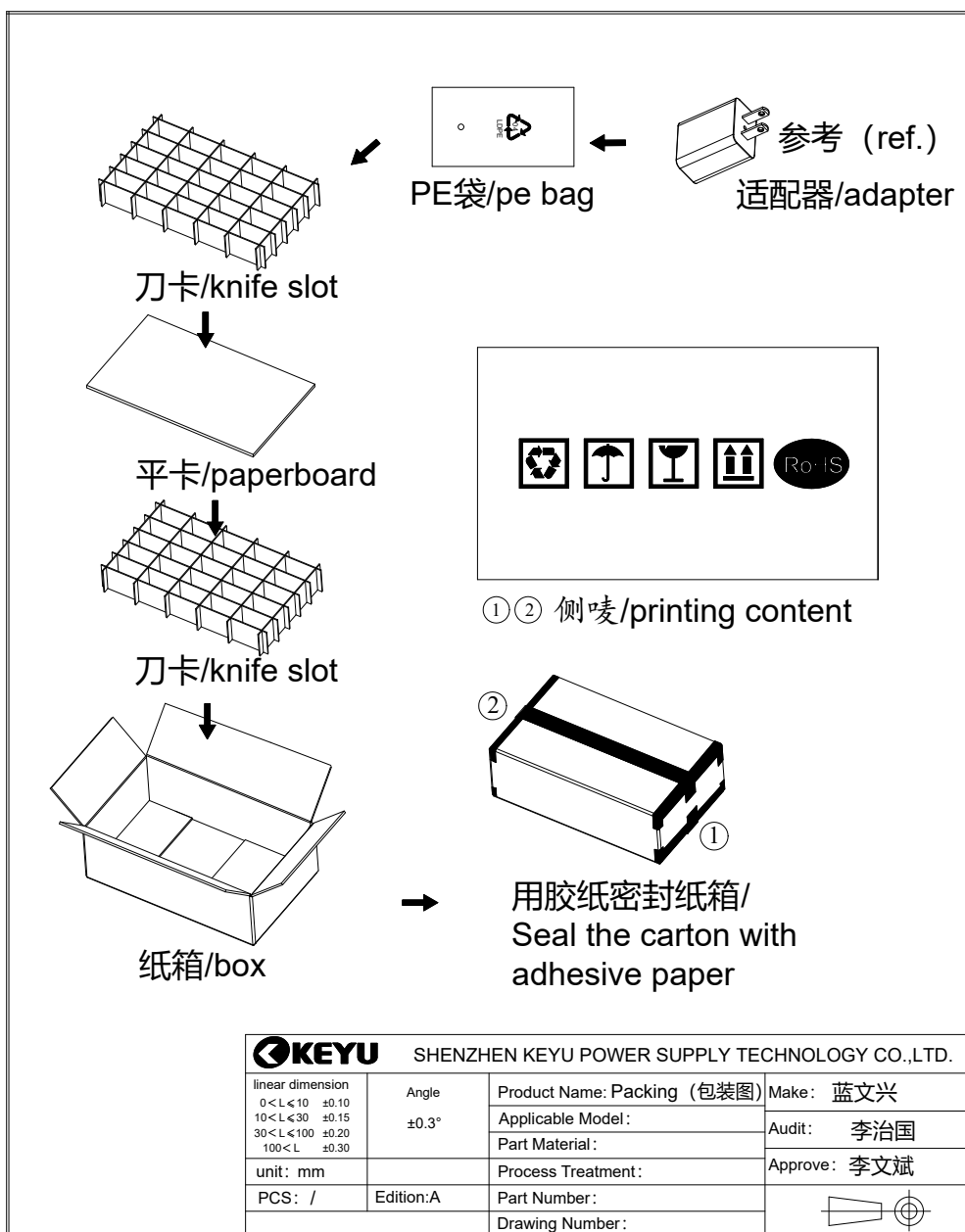

技术要求/technical request:



1. PE 袋/PE bag: **200*120mm**

(带线产品，默认 PE 袋只套本体，线材不装入 PE 袋)

Adapters with wires, PE bags only contain adapters, wires are not packed in PE bags

2. 纸箱/BOX: **570*340*197mm** 材质/material:K=K

3. **50** 个/箱 (**50PCS/BOX**)

 	佰善智能科技（湖北）有限公司 Baishan Intelligent technology (Hubei) Co., Ltd. 深圳市科宇电源科技有限公司 Shenzhen Keyu Power Supply Technology Co., Ltd.		REVISION (版本)	A/0
			DATE (日期)	2026-02-06
PART NUMBER (样单编号)	KA1947009	CUSTOMER MODEL (客户型号)		

15. List of key materials (关键材料清单)

品名	规格	组成量	单位	位号
保险丝	31TD T2A/250V Φ 3.6*10mm 玻璃延时慢断 立式 脚长 3.6 \pm 0.3 加套管 泓达	1	PCS	F1
电解电容	10uF/400V \pm 20% 105 $^{\circ}$ C Φ 8*12mm RL 脚长 3.0 \pm 0.3mm 凯特/黄宝石/新熠杰	1	PCS	EC1
电解电容	15uF/400V \pm 20% 105 $^{\circ}$ C Φ 10*15mm 16max YL 2000H 脚长 3.0 \pm 0.3mm 晶正/凯特/新熠杰	1	PCS	EC2
变压器	EE19 加宽 L=1.80mH KA1801A-5V B 版	1	PCS	T1
安规 Y 电容	HT Y1 102M/400V Y5V P=10mm 外 K 脚 脚长 3.5 \pm 0.3mm 浩田	1	PCS	CY1
光耦 IC	BPC817C CTR:200-400 DIP-4 佰鸿/亿光/光宝	1	PCS	U2
肖特基二极管	DK5V45R15ST 45V/15MR T0-220F 塑封 东科	1	PCS	D2
插件 IC	DP2360 DIP-8 德普微	1	PCS	U1
共模电感	UU9.8 L \geq 22mH 线径 0.27mm 极佳 无卤	1	PCS	LFE1
压敏电阻	MYD-10K681 \pm 10% 420VAC P=7.5mm 脚长 3.3 \pm 0.3mm 祥泰/松田 无卤	1	PCS	VR1
贴片整流桥堆	ABS210-CY 2A1KV 60MIL 康虹/合科泰 无卤	1	PCS	BG1
贴片整流二极管	M7F 1A/1KV 46MIL SMAF 旭茂微/康虹/鲁光	1	PCS	D4
贴片整流二极管	FM4007 1A/1KV SOD-123FL 康虹	1	PCS	D5
稳压 IC	CJ431B \pm 0.5% 36V SOT-23 长电/UTC 无卤	1	PCS	U3
贴片稳压二极管	1/2W 6.8V SOD-123 塑封 鲁光	1	PCS	ZD1
PCB	KA1801A Rev: B L57.0mm*W35.0mm*T1.6mm 材质: 22F	1	PCS	
电解电容	4.7uF/50V \pm 20% 105 $^{\circ}$ C Φ 5*11mm HM 2000H P=2.5 编带 低温特性 晶正/龙奇/凯特/黄宝石/黄宝石/新熠杰	1	PCS	EC3
电解电容	1500uF/6.3V \pm 20% 105 $^{\circ}$ C Φ 8*14mm GF P=2.5mm 编带 凯特/新熠杰	1	PCS	EC4
固态电容	560uF/6.3V \pm 20% 105 $^{\circ}$ C Φ 6.3*9mm PC P=2.5mm 编带 永立/万京源/华科	1	PCS	EC5