

MONTAGEANLEITUNG für den Stuhl ELYSEE

1

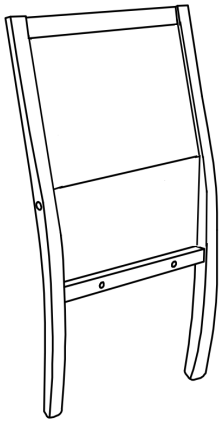

X1

2

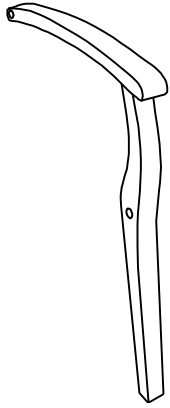

X1

Links

3

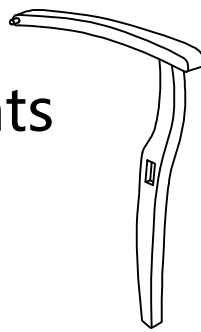

X1

Rechts

4

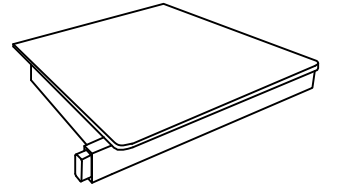

X1

A



X2

B



X4

C



X6

D



X2

E

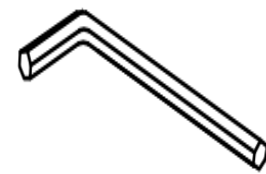

X1

F



X4

Schritt 1

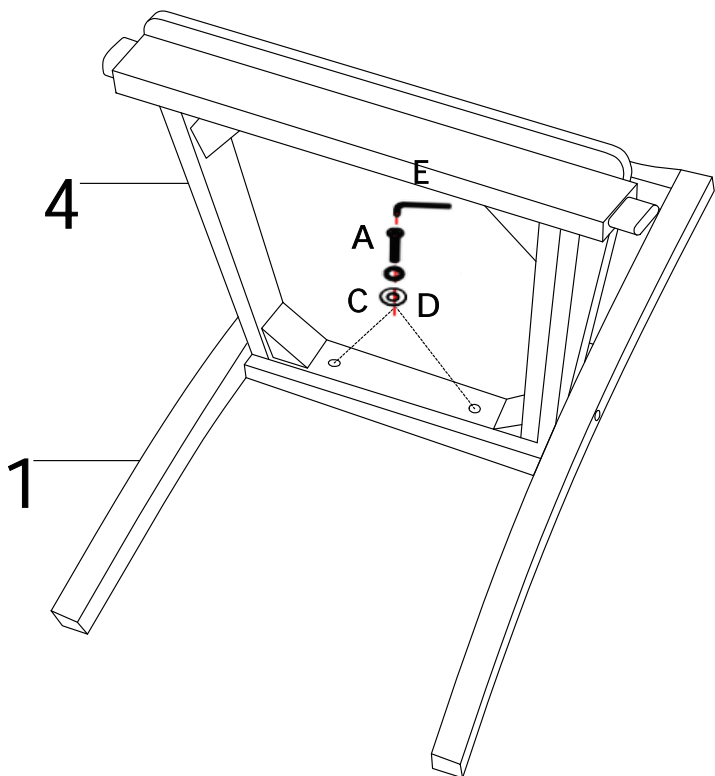

Schritt 2

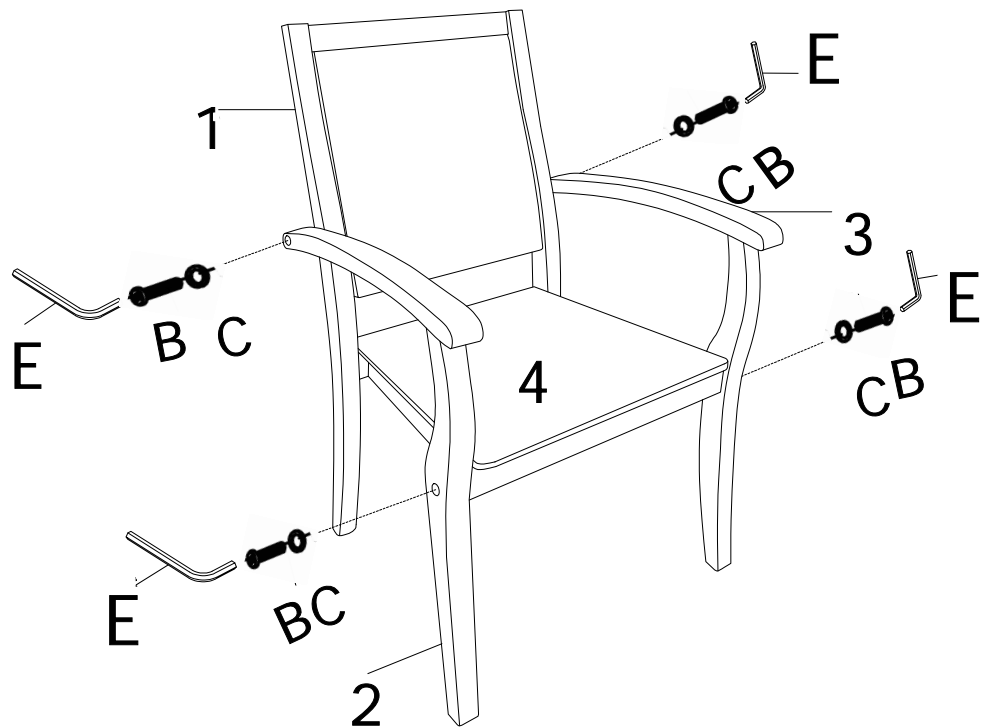

Schritt 3

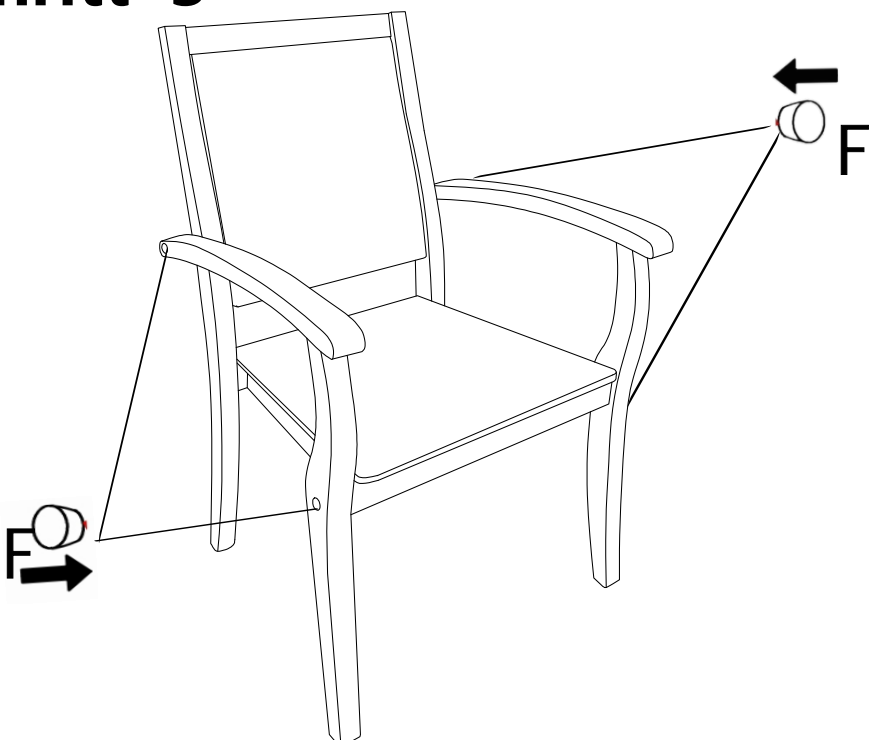

Schritt 4

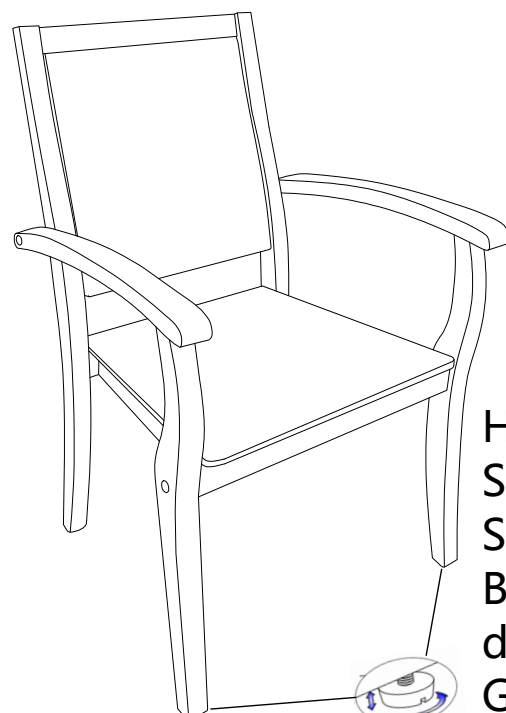

HINWEIS: Stellen Sie die Höhe der Stuhlbeine bei Bedarf mit Hilfe der verstellbaren Gleiter ein